

Burner systems:

- G45-GL-16/19(N,P)A-SS
- G45-GL-18(N,P)A-SS
- G45-GL-24(N,P)A-SS
- G45-GL-30(N,P)A-SS
- G45-GL-36(N,P)A-SS

Regulated burner system for use with propane or natural gas



DESIGN CERTIFIED to

- ANSI Z21.60b-2004
- CSA 2.26b-2004
- ANSI Z21.97 Draft D
- CAN1-2.21-M85

**FOR INSTALLATION IN
SOLID-FUEL BURNING
FIREPLACES**

**FOR USE WITH
FYRE GLASS / FYRE GEMS**

G45-GL STAINLESS STEEL BURNER FOR INDOOR OR OUTDOOR USE

Important: Read this manual carefully before starting installation of the burner system.

WARNING

If the information in this manual is not followed exactly, a fire or explosion may result, causing property damage, personal injury, or loss of life.

Do not store or use gasoline or other flammable vapors and liquids in the vicinity of this or any other appliance.

An LP-cylinder shall not be stored in the vicinity of this or any other appliance.

WHAT TO DO IF YOU SMELL GAS:

- Do not try to light any appliance.
- Do not touch any electrical switch; do not use any phone in the building.
- Immediately call the gas supplier from a neighbor's phone and follow the gas supplier's instructions.
- If you cannot reach the gas supplier, call the fire department.

Installation and service must be performed by an NFI Certified or other qualified professional installer, service agency, or the gas supplier.

The installation of appliances designed for manufactured home (U.S. only) or mobile home installation must conform with the Standard CAN/CSA Z240 MH, Mobile Housing, in Canada, or with the Manufactured Home Construction and Safety Standard, Title 24 CFR, Part 3280, in the United States, or when such a standard is not applicable, ANSI/NCSCBS A225.1/NFPA 501A, Manufactured Home Installations Standard.

CODE AND SUPPLY REQUIREMENTS

The installation and the provisions for combustion and ventilation air must conform with local codes and ordinances, or in the absence of local codes, with the latest *National Fuel Gas Code, ANSI Z223.1/NFPA 54*, the *Natural Gas and Propane Installation Code, CSA B149.1*, or *International Fuel Gas Code*.

⚠ WARNING

Improper installation, adjustment, alteration, service, or maintenance can cause injury or property damage. Read the installation, operating and maintenance instructions thoroughly before installing or servicing this equipment.

This appliance is designed as an **attended appliance**. Adults **must** be present when the unit is operating. **DO NOT** leave this unit burning when unattended. If this product is left burning unattended it may cause damage or serious injury.

INSTALLER: Leave this manual with the appliance.
CONSUMER: Retain this manual for future reference.



Systèmes de brûleur:

G45-GL-16/19(N,P)A-SS
 G45-GL-18(N,P)A-SS
 G45-GL-24(N,P)A-SS
 G45-GL-30(N,P)A-SS
 G45-GL-36(N,P)A-SS

Système réglé de
 brûleur pour l'usage
 avec du propane et le
 gaz naturel



CONCEPTION CERTIFIÉE à

ANSI Z21.60b-2004
 CSA 2.26b-2004
 ANSI Z21.97 Draft D
 CAN1-2.21-M85

**POUR L'INSTALLATION EN
 CHEMINÉES BRÛLANTES DE
 COMBUSTIBLE SOLIDE***

**POUR L'USAGE AVEC
 LE VERRE / GEMMES**

BRÛLEUR À L'ACIER INOXYDABLE G45-GL POUR L'USAGE D'INTÉRIEUR OU EXTÉRIEUR

Important: Read this manual carefully before starting installation of the burner system.

AVERTISSEMENT

Si l'information en ce manuel n'est pas suivie exactement, un incendie ou une explosion peut résulter, entraînant des dégâts matériels, le dommage corporel, ou des pertes humaines.

Ne stockez pas ou n'employez l'essence ou d'autres vapeurs et liquides inflammables à proximité de ceci ou d'aucun autre appareil.

Un LP-cylindre ne sera stocké à proximité de ceci ou d'aucun autre appareil.

CE QUI À FAIRE SI VOUS SENTEZ LE GAZ:

- N'essayez pas de n'allumer aucun appareil.
- Ne touchez aucun commutateur électrique ; n'utilisez aucun téléphone dans le bâtiment.
- Appelez immédiatement le fournisseur de gaz du téléphone d'un voisin et suivez les instructions du fournisseur de gaz.
- Si vous ne pouvez pas atteindre le fournisseur de gaz, appelez les corps de sapeurs-pompiers.

L'installation et le service doivent être assurés par un NFI certifié ou tout autre installateur professionnel qualifié, agence de service, ou le fournisseur de gaz.

L'installation des appareils conçus pour la maison manufacturée (États-Unis seulement) ou l'installation de caravane résidentielle doit se conformer au CAN/CSA standard Z240 MH, logement mobile, au Canada, ou à la construction et au standard de sécurité à la maison manufacturés, intitulent 24 CFR, la partie 3280, aux États-Unis, ou quand une telle norme ne s'applique pas, à ANSI/NCSBCS A225.1/NFPA 501A, installations à la maison manufacturées standard.

CODEZ ET FOURNISSEZ LES CONDITIONS

Ce brûleur extérieur doit être installé selon des codes locaux et des ordonnances, ou en l'absence des codes locaux, avec le plus défunt code national de gaz de carburant, la norme ANSI Z223.1/NFPA 54, le code d'installation de gaz naturel et de propane, CSA B149.1, ou code international de gaz de carburant.

⚠ AVERTISSEMENT

L'installation, l'ajustement, le changement, le service, ou l'entretien inexact peuvent causer des dommages ou des dégâts matériels. Lisez l'installation, l'opération et les instructions d'entretien complètement avant d'installer ou entretenir cet équipement.

Cet appareil est conçu comme appareil occupé. Les adultes doivent être présent quand l'unité fonctionne. Ne laissez pas ce brûlant d'unité si sans surveillance. Si ce produit est laissé sans surveillance brûlant il peut causer des dommages ou des dommages sérieux.

INSTALLATEUR: Laissez ce manuel avec l'appareil.

CONSOMMATEUR: Maintenez pour la future référence.

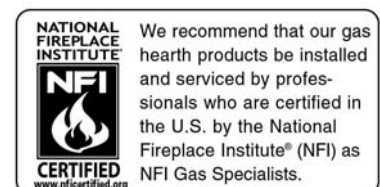

TABLE OF CONTENTS

3	SAFETY INFORMATION
4	PARTS LIST
5	BEFORE YOU BEGIN - IMPORTANT INFORMATION
6	GLASS / GEMS QUANTITY DETERMINATION
7	INSTALLATION
7	INSTALLING THE BURNER
9	GLASS / GEMS PLACEMENT
9	BURNER PREPARATION
10	NOTES PAGE
11	OPERATING THE BURNER SYSTEM - LIGHTING AND EXTINGUISHING
13	CLEANING AND MAINTENANCE
13	MAINTENANCE
13	CLEANING
13	SERVICE
13	FLAME DESCRIPTION
14	TROUBLESHOOTING
16	WARRANTY

SAFETY INFORMATION

1. Children and adults should be alerted to the hazards of high surface temperatures and should stay away to avoid burns or clothing ignition.
2. Young children should be carefully supervised when they are in the area of the appliance.
3. Clothing or other flammable materials should not be placed on or near the appliance.
4. Any guard or other protective device removed for servicing the appliance must be replaced prior to operating the appliance.
5. Installation and repair must be done by a qualified professional service person. The appliance must be inspected before use and at least annually by a qualified professional service person. More frequent cleaning may be required as necessary.
6. Solid fuels shall not be burned in a fireplace where this burner system is installed.
7. Keep the appliance area clear and free from combustible materials, gasoline and other flammable vapors and liquids.
8. The burner assembly must be replaced prior to the appliance being put into operation if it is evident that the burner assembly is damaged. Contact your local dealer for replacement parts.
9. A fireplace screen must be in place when the system is burning. Provisions for adequate combustion air must be maintained. Unless other provisions for combustion air are provided, the screen shall have an opening(s) for introduction of combustion air. Combustion air is adequate when all flames curl into the fireplace and away from the screen. When a glass fireplace enclosure (door) is used, leave the doors fully open when the system is in operation.

PARTS LIST

Before installation, check that your gas burner system is complete. See the PARTS LIST below. If any parts are missing or damaged, contact your Real-Fyre® dealer before installing or using the burner. Be sure you know the model and size of your set when ordering options or replacement parts and accessories.

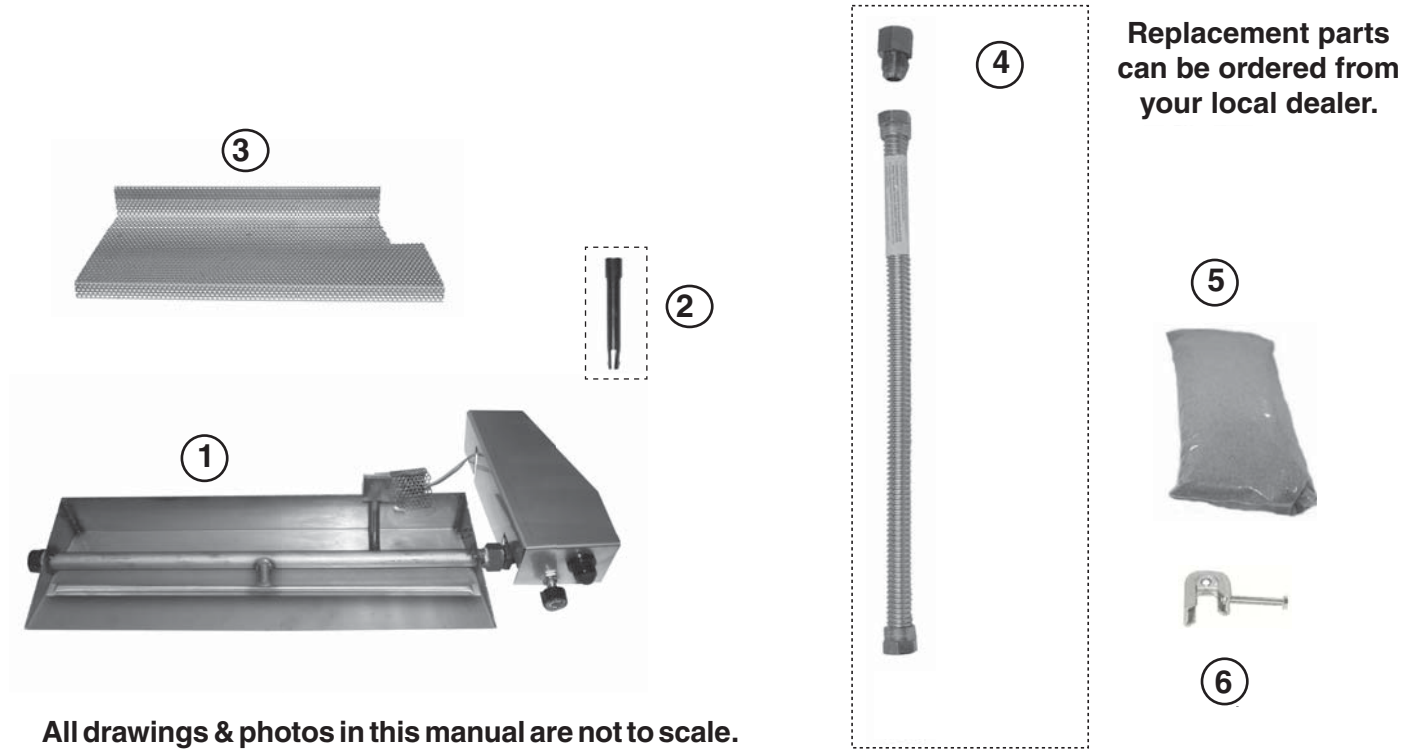

All drawings & photos in this manual are not to scale.

ITEM	DESCRIPTION	QTY
1.	Burner pan and valve assembly	1
2.	Handle extension	1
3.	Separator screen	1
4.	Connector kit (with adapter)	1
5.	Select sand granules (natural gas only) or vermiculite granules (propane gas only)	1
6.	Damper clamp	1

Fyre glass / Fyre gems are purchased and packaged separately. Quantity will vary, depending on selection. Glass and gems are available in various colors; contact your dealer for further details.

BEFORE YOU BEGIN - IMPORTANT INFORMATION

Before You Begin, review the information and safeguards below about the installation and operation of the Real-Fyre® burner system.

Check to be sure that the fireplace meets the venting and construction requirements for the installation of the burner system.

THIS BURNER IS DESIGNED FOR USE WITH PROPANE OR NATURAL GAS. Never use natural gas in a burner system designed for use with propane gas and never use propane gas in a burner designed for natural gas.

This product is not recommended for use in temperatures below 32°F.

Be sure the burner system is properly sized for the fireplace. Improper sizing may negatively impact the proper drafting of the fireplace. Fig. 5-1 illustrates the critical dimensions of the firebox.

This burner system must be installed by an NFI Certified or other qualified professional installer. The burner system is to be installed only in a solid-fuel burning fireplace with a working flue and constructed of noncombustible material. The fireplace must have an open damper. The chimney must be free of any obstructions.

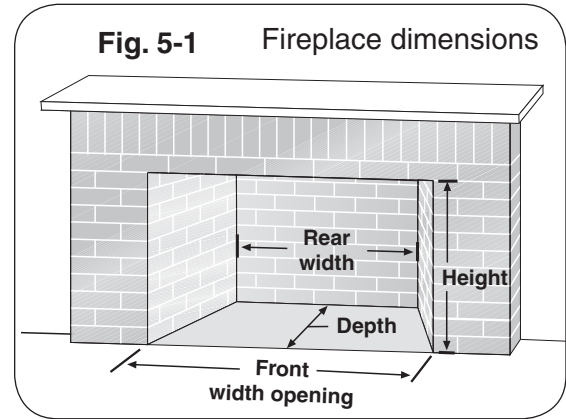

The fireplace must have a gas supply line that has been installed by a qualified technician in accordance with all local codes. The gas supply line must have a ½" minimum interior diameter. If the gas line to the fireplace is longer than 20', a larger diameter line may be necessary.

Be sure to clean the fireplace floor of any ashes or other foreign materials. It is recommended that the fireplace and chimney be examined and cleaned by a chimney sweep or other qualified person before you install the burner system, and annually thereafter.

Required Gas Pressure: The minimum inlet gas-supply pressure for the purpose of input adjustment is 5" for natural gas and 10" for propane gas. The maximum inlet gas-supply pressure for this burner is 10.5" for natural gas and 13" for propane gas.

Testing the Gas Supply System: The burner system and its individual shut-off valve must be disconnected from the gas supply piping system while performing any tests of the piping system at pressures in excess of ½ psig (3.5 kPa). The burner system must be isolated from the gas supply piping system by closing its individual manual shut-off valve during any pressure testing of the gas supply piping system at test pressures equal to or less than ½ psig (3.5 kPa). This is accomplished by closing the gas supply line valve, which is required by NFPA 54, section 5.54.

Burner size	Min. Fireplace Dimensions				BTU	
	Width		Depth	Height	NAT.	L.P.
	Front*	Rear				
16/19"	26"	20"	12"	18"	35k	28k
18"	28"	22"	12"	18"	65k	40k
24"	34"	28"	12"	18"	75k	60k
30"	40"	34"	12"	18"	85k	70k
36"	46"	40"	12"	18"	95k	80k

* This required width allows for centering of the system.

Note: Rear width is at corresponding depth.

Minimum Free Opening Area of Chimney Damper for Venting (sq. in.)					
For Factory-Built Fireplaces *					
Chimney Height	16/19"	18"	24"	30"	36"
15' (min.)	22	41	47	53	60
20'	20	37	43	48	54
30'	18	33	38	43	48

* For Masonry-Built Fireplaces; add 4 sq. in. to amount shown.

Important: For safe operation and proper performance of this product and to comply with certification, listings, and building code acceptances, use ONLY Peterson Real-Fyre® controls, parts, and accessories that have been specifically listed or certified for use with this burner system. Use of other controls, parts, or accessories is prohibited and will void all warranties, certifications, listings, and building code approvals, and may cause property damage, personal injury, and loss of life.

GLASS / GEMS QUANTITY DETERMINATION

CAUTION: Sand granules are for use with natural gas systems only. Always use lava granules for propane gas systems.

The granules that come with the burner system are pre-measured and must be used per these instructions (see GLASS / GEMS PLACEMENT section).

Decorative glass / gems (purchased separately) must be placed to cover the burner (but not on the valve or pilot, if equipped). See Table 6-1 for the minimum bag requirement depending on your burner size. Additional glass / gems may be purchased and placed around the burner if desired.

Should you wish to fill the entire fireplace floor with glass / gems; instead use Table 6-2 to determine how many bags of glass / gems to order **based on fireplace size**.

One 10-lb. bag of glass / gems fills approximately 144 cubic inches.

CAUTION: When covering the burner with glass / gems; do not exceed 1" above the top of the burner. Additional glass / gems directly on top of the burner may result in unsafe ignition.

Minimum burner coverage requirement Table 6-1	Burner size				
	16/19	18	24	30	36
Glass / gem 10 lb. bag(s) needed	1	1	1	1	1

- OR -

Fireplace complete coverage Table 6-2	Fireplace				Glass / gems 10 lb. bags needed for 2" depth
	Opening size	Center width (in.)	Front to back depth (in.)	Area (sq. in.)	
Standard Fireplace Sizes	28"	25	16	400	6
				540	8
	36"	30	23	690	10
	32" see-thru	31	23	713	10
	42"	36	30	828	12
				1085	15
	50"	46	33	1334	19

These bag quantities listed allow for an approximate 2" depth of glass / gems in the entire fireplace floor, without a burner. (The volume of the burner will take up some space, allowing for some excess glass to be used as desired, or stored as extra for later use.)

Your fireplace area can be determined by measuring the center width of your fireplace in inches and multiplying by the depth from front to back in inches. You can then use the area column in the table above to approximate the number of bags needed.

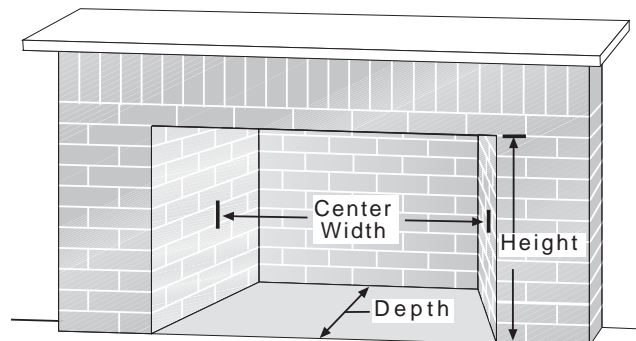

INSTALLATION

The damper clamp with hex bolt (Fig. 7-1) is provided as a means to prevent full closure of the damper blade. The clamp is easily attached to most damper blades with pliers or a wrench, and must be permanently installed. The clamp is designed to prevent accidental closure of the damper when installed as illustrated (Fig. 7-2 and Fig. 7-3). Should the clamp not fit, or fail to provide the permanent vent opening listed in the table found above, have a permanent stop installed, remove the damper blade, or have the damper cut to provide the minimum permanent opening required.

Note: These are minimum damper opening specifications. The damper must be completely opened when operating this gas appliance to achieve the best ventilation possible.

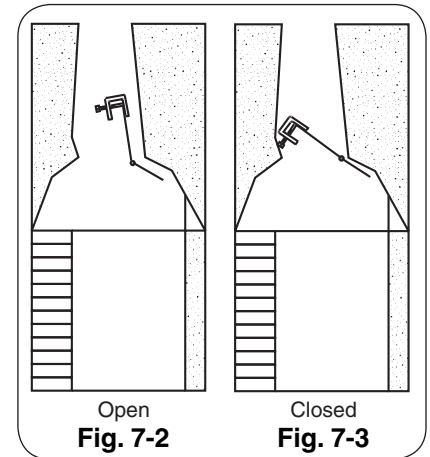
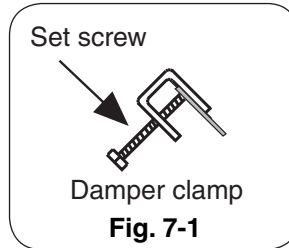

INSTALLING THE BURNER

The Real-Fyre burner system must be installed by a qualified professional service technician. Instructions must be followed carefully to ensure proper performance and full benefit from the burner system. **Check to be sure the burner system is designed and labeled for the type of gas (natural or propane gas) supplied to the fireplace. Fireplace floor must be level, clean, and smooth.**

WARNING: Failure to position the parts in accordance with these diagrams or failure to use only parts specifically approved with this appliance may result in property damage or personal injury.

REFER TO THE PARTS LIST WHEN FOLLOWING THESE INSTRUCTIONS.

1. MAKE SURE THE FIREPLACE GAS SUPPLY IS TURNED OFF.
2. Locate the handle extension included with your system. Remove the black ON/OFF control knob from the burner assembly, attach it to the narrow forked end of the extension, and attach the extension to the valve stem (that the knob originally was connected to). Reference the figure on the next page and the photos in the GLASS / GEMS PLACEMENT section for orientation.
3. Locate the gas-supply stub inside the fireplace and remove the cap, if attached (see Fig. 7-4).

CAUTION: When removing the cap, make sure the stub does not turn, loosening the connection inside the wall.

4. Attach the nut end of the flex connector (Item 3) to the adapter found on the regulator behind the valve. Tighten securely.
5. Place the burner system into the fireplace so that it is centered and the open burner pan faces outward.

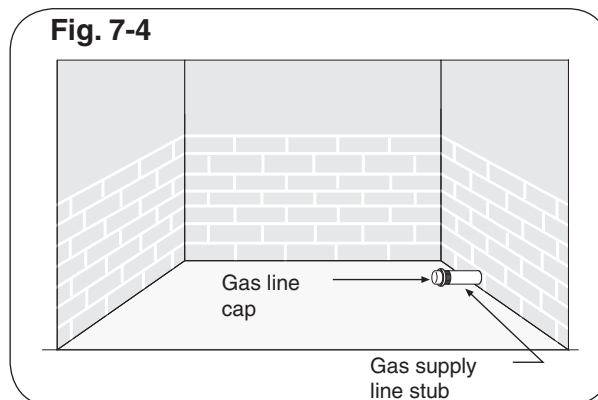

INSTALLATION (cont.)

6. **Be sure gas to the fireplace is off.** Remove the adapter that is loosely connected to the open end of the flex connector. Attach the adapter to the gas-supply stub using a pipe compound resistant to all gases. Tighten securely. Then attach the open end of the flex connector to the adapter. Tighten securely. Ensure the pan rests level on the fireplace floor after connection. Adjust the pan if necessary.
7. **LEAK TEST:** Be sure the control valve is in the OFF position. Turn on the fireplace gas supply, and test at all connections for leaks using the appropriate soapy water solution. If bubbles appear, a leak is present. Turn off the gas and tighten at all connections. Repeat until no leaks are present. If a leak persists, turn off the gas supply and contact the local gas company or dealer. **NEVER USE A FLAME TO CHECK FOR LEAKS.**

Turn off the gas supply prior to proceeding.

Important: Heatshields must be in place during operation of the burner system. Overheating of the valve will cause shut down of the burner system or other operating problems.

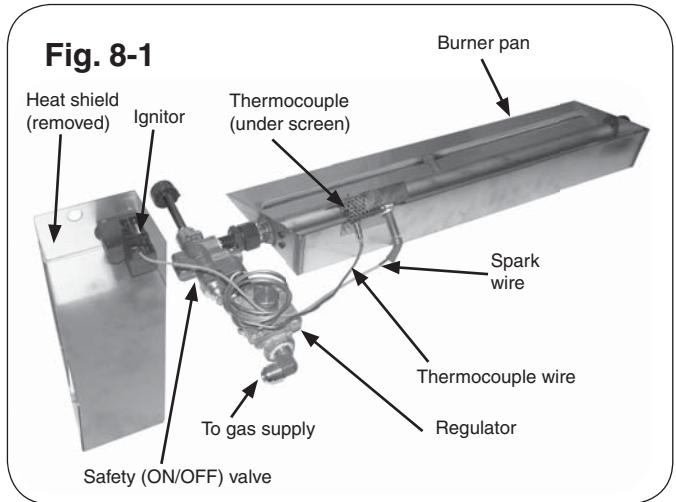

GLASS / GEMS PLACEMENT

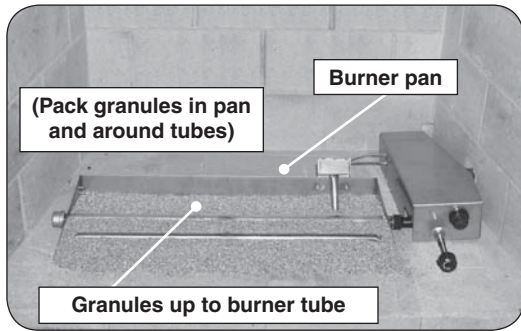

Fig. 9-1

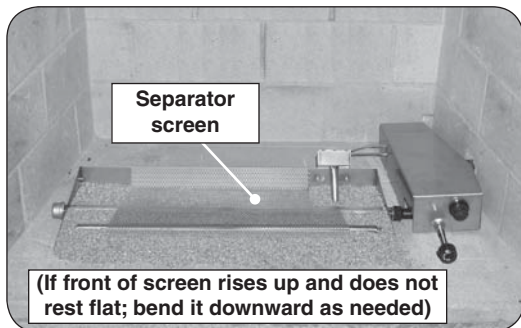

Fig. 9-2

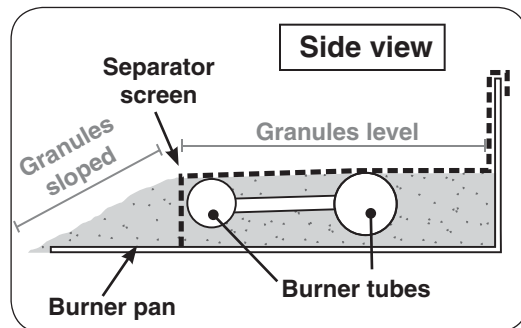

Fig. 9-3

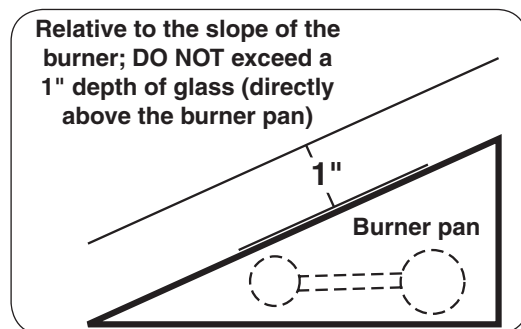

Fig. 9-4

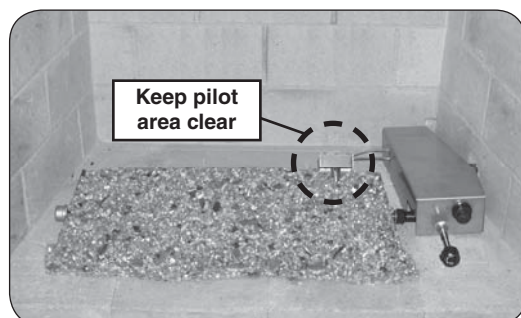

Fig. 9-5



Fig. 9-6

BURNER PREPARATION

After hooking up the burner to the fireplace gas supply, the decorative media (granules and glass / gems) must be added for the burner to function as designed.

Note: Installation is the same for glass and gems. Glass shown here. These instructions show sand granules being used as a base for the glass, but only natural-gas burners use sand. For propane burners, follow these instructions using lava granules.

WARNING

The burner and pilot must be **OFF** (fully extinguished), and all valve covers must be in place before pouring media onto the burner. It may also be necessary to temporarily cover the pilot assembly to keep media out of it during this procedure.

GRANULE PLACEMENT

1. Pour the granules into the pan until they just cover the burner tubes. Then pack the granules in the pan and around the burner tubes. Add additional granules as needed to end with the granules **level** with the top of the burner tubes. Slope the granules in the front portion of the pan. See Fig. 9-1 and Fig. 9-3.
2. Place the separator screen over the granules such that the rear of the screen hooks over the top and back of the burner pan, as shown in Fig. 9-2 and Fig. 9-3. If the front of the screen rises up from the floor of the pan, bend it downward as needed.

Note: The screen must correctly rest onto the burner pan. If it sits too high; remove some of the granules to ensure a proper fit. **DO NOT** allow for any granules to be above the screen.

GLASS / GEMS PLACEMENT

CAUTION: Glass pieces may have sharp edges. Be careful handling the glass. Use hand protection, such as gloves, if necessary.

1. Pour the glass / gems directly on top of the granules and screen so that the burner pan is covered completely and evenly. Relative to the slope of the burner; DO NOT exceed a 1" depth of glass (directly above the burner pan) as shown in Fig. 9-4. DO NOT place glass directly under the pilot. See Fig. 9-5 and Fig. 9-6.

Note: At this stage the burner will function as designed; however, more glass / gems may be added around the burner for decorative purposes. If glass / gems are desired behind the burner pan, they may be left at a lower level than the back of the pan, as shown in Fig. 9-6, or raised up to or above the level in the back of the pan.

2. Add additional glass / gems around the burner pan as desired (Fig. 9-6). (Be sure to keep pilot area clear.)

NOTES PAGE

Please use this page to record any information about your burner system that you may want to have at hand.

OPERATING THE BURNER SYSTEM - LIGHTING AND EXTINGUISHING

FOR YOUR SAFETY, READ BEFORE LIGHTING

WARNING: If you do not follow these instructions exactly, a fire or explosion may result, causing property damage, personal injury, or loss of life.

- A. BEFORE LIGHTING**, smell all around the burner system area for gas. Be sure to smell next to the floor because some gas is heavier than air and will settle on the floor.
- B. IF YOU SMELL GAS:**
- **Shut off the gas to the appliance.**
 - **Extinguish any open flame.**
 - **If odor continues, keep away from the appliance, and immediately call the gas supplier or fire department.**
- C.** Use only your hand to push in or turn the gas control knob. Never use tools. If the knob will not push in or turn by hand, don't try to repair it. Call a qualified service technician. Force or attempted repair may result in fire or explosion.
- D.** Do not use the burner system if any part has been underwater. Immediately call a qualified service technician to inspect the burner system and to replace any part of the control system and any gas control that has been underwater.

LIGHTING THE BURNER SYSTEM

1. After you have finished checking for leaks, ensure that the unit is turned completely off by pushing in the ON/OFF control knob and turning clockwise toward **OFF** until you reach a stop.
2. Turn the ON/OFF control knob counter-clockwise to the **ON** position. **DO NOT PUSH KNOB IN!**

Note: You should not hear or smell any gas at this point.

3. Wait five (5) minutes to clear out any gas. Smell for gas, including near the floor. If you smell gas, stop and follow step B of the safety information above. If you don't smell gas, go to the next step.

4. LIGHTING INSTRUCTIONS

- a. Press and hold in the electronic ignitor button. The ignitor will spark with a rapid clicking noise.
- b. While holding in the electronic ignitor, push in the ON/OFF control knob to open the valve. Burner will now ignite at the maximum BTU input.
- c. Continue to hold knob for 10-15 seconds; this will allow the safety valve to activate and the main burner to remain burning.

Note: Electronic igniter may not properly operate when exposed to high moisture. To manually light the burner, lay a long-stem match on the surface of the embers near the gas inlet (**do not hold the match in your hand**) or use a lighted long necked butane lighter.

TURNING OFF THE BURNER SYSTEM

1. Push in the ON/OFF control knob and turn clockwise toward **OFF** until you reach a stop (burner will extinguish).

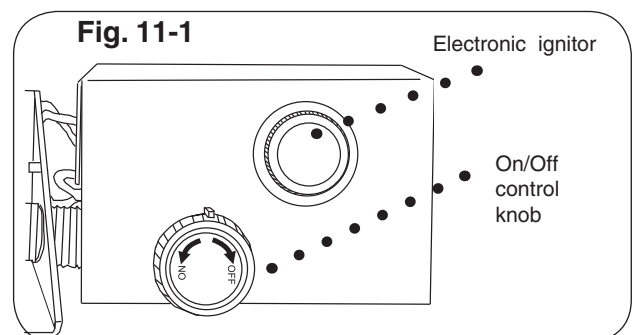

ACTIONNANT LE SYSTÈME DE BRÛLEUR - ÉCLAIRAGE ET S'ÉTEIGNANT

POUR VOTRE SÛRETÉ, LISEZ AVANT L'ALLUMAGE

AVERTISSEMENT: Si vous ne suivez pas ces instructions exactement, une incendie ou une explosion peut résulter, entraînant des dégâts matériels, le dommage corporel, ou des pertes humaines.

- A. AVANT L'ALLUMAGE**, sentez tous autour du secteur de système de brûleur pour le gaz. Soyez sûr de sentir à côté du plancher parce qu'un certain gaz est plus lourd que l'air et arrangez sur le plancher.
- B. SI VOUS SENTEZ LE GAZ:**
- Coupez le gaz à l'appareil
 - Éteignez-vous n'importe quelle flamme nue.
 - Si l'odeur continue, gardez à partir de l'appareil, et appelez immédiatement le fournisseur ou les corps de sapeurs-pompiers de gaz.
- C.** Utilisez seulement votre main pour enfoncer ou pour tourner le bouton de commande de gaz. N'utilisez jamais les outils. Si le bouton n'enfoncera pas ou ne tournera pas à la main, n'essayez pas de le réparer. Appelez un technicien qualifié de service. La force ou la réparation essayée peut avoir comme conséquence l'incendie ou l'explosion.
- D.** N'employez pas le système de brûleur si n'importe quelle partie a été sous-marine. Appelez immédiatement un technicien qualifié de service pour inspecter le système de brûleur et pour remplacer n'importe quelle partie du système de contrôle et de n'importe quelle commande de gaz qui a été sous-marine.

ALLUMAGE DU SYSTÈME DE BRÛLEUR

1. Après que vous ayez fini la vérification les fuites, assurez-vous que l'unité est arrêtée complètement en enfonçant le bouton de commande "MARCHE/ARRÊT" et en tournant dans le sens des aiguilles d'une montre vers AU LOIN jusqu'à ce que vous atteigniez un arrêt.
2. Tournez le bouton de commande "MARCHE/ARRÊT" dans le sens contraire des aiguilles d'une montre à la position de fonctionnement. **NE PUSSEZ PAS LE BOUTON DEDANS!**

Note: Vous ne devriez entendre ou sentir aucun gaz en ce moment.

3. Attendez cinq (5) minutes pour dégager dehors n'importe quel gaz. Sentez pour le gaz, y compris près du plancher. Si vous sentez le gaz, arrêtez et suivez l'étape B d'information de sûreté ci-dessus. Si vous ne sentez pas le gaz, passez à la prochaine étape.

4. INSTRUCTIONS D'ÉCLAIRAGE

- a. Pressez et tenez dans le bouton électronique d'allumeur. L'allumeur étincellera avec un bruit cliquant sur rapide.
- b. Tout en se tenant dans l'allumeur électronique, enfoncez le bouton de commande "MARCHE/ARRÊT" pour ouvrir la valve. Le brûleur mettra à feu maintenant à l'entrée de Btu de maximum.
- c. Continuez à tenir le bouton pendant 10-15 secondes; ceci permettra à la soupape de sûreté d'activer et au brûleur principal de rester brûlant.

Note: La bougie électronique peut correctement ne pas fonctionner une fois exposée à l'humidité élevée. Pour allumer manuellement le brûleur, étendez une allumette de long-tige sur la surface des braises près de l'admission de gaz (ne tenez pas l'allumette dans votre main) ou employez un long allumeur étranglé allumé de butane.

ARRÊTER LE SYSTÈME DE BRÛLEUR

1. Enfoncez le bouton de commande "MARCHE/ARRÊT" et tournez dans le sens des aiguilles d'une montre vers AU LOIN jusqu'à ce que vous atteigniez un arrêt (le brûleur s'éteindra).

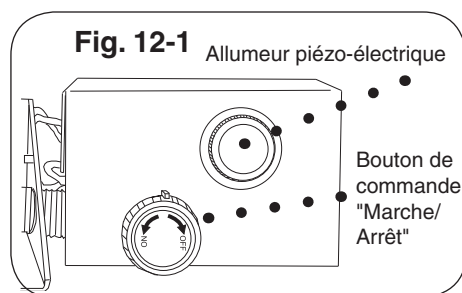

MAINTENANCE

Once installed and operating properly, your Real-Fyre® burner will require regular maintenance. You should inspect your burner and control for the following:

1. Moisture may cause the glass / gems in your burner pan to settle. To improve the burn, follow these tips:
 - a. Settling of glass / gems - Using a screwdriver or flat-blade knife, carefully stir the glass, loosening the material. Clear up any spills.
2. Debris around the control -Inspect control and pilot to be sure they are free of dirt or debris.
3. **Insects and burner blockage** - Check the burner ports and burner orifice, to make sure they are free from debris. Blocked burner ports and orifices may result in a fire.

CLEANING

The pilot assembly must be kept clean and clear of debris at all times for the fireplace burner system to be safely and effectively operated. Dust, carpet fibers, paper, spider webs, pet hair, etc. in the fireplace or on the burner assembly can affect operation of the burner and pilot assembly. Vacuum or use compressed air from a can or compressor to clean out the burner assembly, pilot assembly area, and pilot air intake openings, and burner orifices. Blockage in this area will affect the operation of pilot assembly.

SERVICE

While some minor service conditions can be handled by the owner of the burner, a qualified professional service technician should be called to maintain and service your glass burner and control system. In addition, a periodic examination and cleaning of the solid-fuel-burning fireplace venting system should be conducted by a qualified professional service technician. The TROUBLESHOOTING section of these instructions serves as a guide for ensuring optimum performance of your burner.

To protect your investment in your Real-Fyre® gas fireplace burner system and keep it operating safely for years to come, maintain, clean, and inspect it regularly. We recommend following these instructions at the beginning of each fireplace season and as needed throughout the year, depending on your usage pattern and the environmental conditions in your home. More frequent cleaning and maintenance may be necessary when burning propane gas than with natural gas.

- Check and readjust the burner orifice.
- Clean and test the ignitor and pilot (if equipped).

FLAME DESCRIPTION

Observe the flames. The flames should be blue at the base and a combination of blue / yellow at the body and tips. The flames should be 16" to 18" tall. (See Figure 13-1). Inspect the flames periodically. If flames appear different, contact a qualified professional service technician or your gas supplier to correct the problem.



Fig. 13-1

TROUBLESHOOTING

SYMPTOM	CAUSE	SOLUTION
1. Smoking and/or sooting (IMMEDIATELY STOP USING. Call your gas supplier or another qualified professional installer or service agency.)	A. Poor draft or downdraft	A. Check for chimney blockage. Be sure chimney is at least 3' taller than anything within 10' of it in all directions. If not, consult a chimney sweep. Chimney cap or fan may help. Under severe conditions, you may need to open a window near the fireplace about 1" to 2" when burning the unit.
	B. Damper closed	B. Open damper fully when operating burner system.
	C. Burner is positioned too close to the front of the firebox	C. Move burner system to the center of the firebox.
	D. Improper glass/gems placement or amount	D. See PLACEMENT OF GLASS / GEMS section.
	E. Air mixer on propane set is closed	E. Open air mixer completely.
	F. Improper burner for gas used	F. Use only a natural-gas set with natural gas or use only a propane-gas set with propane gas.
2. Low flame	A. Incorrect decorative media for type of gas used	A. Consult your dealer for proper set.
	B. Insufficient gas supply	B. Other gas appliances may be competing for gas supply. Consult installer or plumber. Orifice size is based upon 7" w.c. pressure for natural gas and 11" w.c. pressure for propane gas. Plumbing must supply adequate pressure.
	C. Blockage or kink in connector kit, plumbing, or burner orifice	C. Clean out blockage. If connector kit is kinked, replace it.
	D. Valve not fully open	D. Open valve fully.

TROUBLESHOOTING (cont.)

SYMPTOM	CAUSE	SOLUTION
3. Uneven flame distribution (Lower at one end of the burner)	A. Clogged or blocked portholes	A. Burner ports can be cleared of foreign objects by running a wire through them.
	B. Insufficient gas pressure and/or supply	B. Consult installer or plumber (see solution 2B).
	C. Decorative media may be packed down too tightly	C. Loosen media around burner pipe by running a kitchen knife along both sides of the pipe. Even out media in burner pan.
	D. Auxiliary shutoff valve partially closed	D. Open valve fully. Usually you will find this along the wall 3' from the fireplace.
4. Flame at air mixer (For propane units)	A. Clogged or blocked burner ports	A. Burner ports can be cleared of foreign objects by running a wire through them.
	B. Insufficient gas pressure and/or supply	B. Consult installer or plumber (see solution 2b).
	C. Decorative media may be packed down too tightly	C. Loosen media around the burner by running a kitchen knife along both sides of the pipe. Be sure granules are used with an air mixer.
	D. Excessive gas pressure	D. Contact your gas supplier.

WARRANTY

PETERSON VENTED DECORATIVE GAS APPLIANCE LIMITED WARRANTY

All Peterson gas logs are **WARRANTED** for as long as you own them (lifetime).

All Peterson burner assemblies are **WARRANTED** for **TEN (10) YEARS**.

All Peterson glass is **WARRANTED** for **TEN (10) YEARS**.

SPK-26 controls are covered by a **THREE (3) YEAR "All Parts" Warranty**.

All other Peterson valves, pilots, and controls are covered by a **ONE (1) YEAR Limited Warranty (excluding batteries)**.

PLEASE KEEP A COPY OF YOUR SALES SLIP FOR PROOF OF PURCHASE

This warranty applies to the original purchaser and to single family residential use only. It commences from date of purchase, and is valid only with proof of purchase.

This warranty does not cover parts becoming defective through misuse, accidental damage, electrical damage, improper handling, storage, and/or installation. Product must be installed (and gas must be connected) as specified in the instructions or operator's manual, by a **qualified professional installer**. Accessories, parts, valves, remotes, etc., when used must be Peterson Co. product.

This warranty **does not** apply to rust, corrosion, oxidation, or discoloration, unless the affected component becomes inoperable. It **does not** cover labor or labor-related charges.

This warranty specifically excludes liability for **indirect, incidental**, or consequential damages. Some states do not allow the exclusion or limitation of incidental or consequential damages, so the above exclusion may not apply to you. This warranty gives you specified legal rights, and you may have other rights that may vary from state to state.

For additional information regarding this warranty, or to place a warranty claim, contact the R.H. Peterson dealer where the product was purchased.

**TO REGISTER YOUR PRODUCT ONLINE GO TO: WWW.RHPETERSON.COM,
AND CLICK ON PRODUCT REGISTRATION. THANK YOU FOR YOUR PURCHASE.**

Quality Check			Date: _____		
Burner Orifices	Nat.	L.P.	Leak Test: _____	Model#:	_____
Main:	_____	_____	Burn Test: _____	Serial#:	_____
Other:	_____	_____	Gas Type: <u>Nat. / L.P.</u>	Air Shutter:	_____
				Inspector:	_____